



UPCOMING ENGINEERING CONTRACTING CO.

COMPANY PROFILE

THE LEADING PROVIDES QUALIFIED CONSULTING PERSONNEL TO THE OIL, GAS, PETROCHEMICAL, INFRASTRUCTURE AND POWER INDUSTRIES SECTOR

UEC was formed in **Saudi Arabia in 2015** and has its global headquarters in Al Khobar, registered with

CR # (Main CR no: 1112100062, Branch CR No: 2051162996).

Our current business activities include professional services related to Civil, HVAC & Electromechanical, Electrical, Fire Protection, Piping, Plumbing, Structural, Painting and coating, Industrial Maintenance, Supply chain, and logistics, including heavy equipment rental services.



**Date
2025**

High Quality Services
Since **2015**

GET IN TOUCH



Tel: +966 13 331 1482
Fax: +966 56 229 4987

P.O. Box 28, Al Khobar
34427, Saudi Arabia

hashar@uecksa.com



UEC
Vision

Expand globally, delivering exceptional services that drive unique client value.



UEC
Mission

Synergizing teamwork, technology, performance, and innovation to deliver exceptional customer satisfaction.

HIGH QUALITY SERVICES SINCE 2015

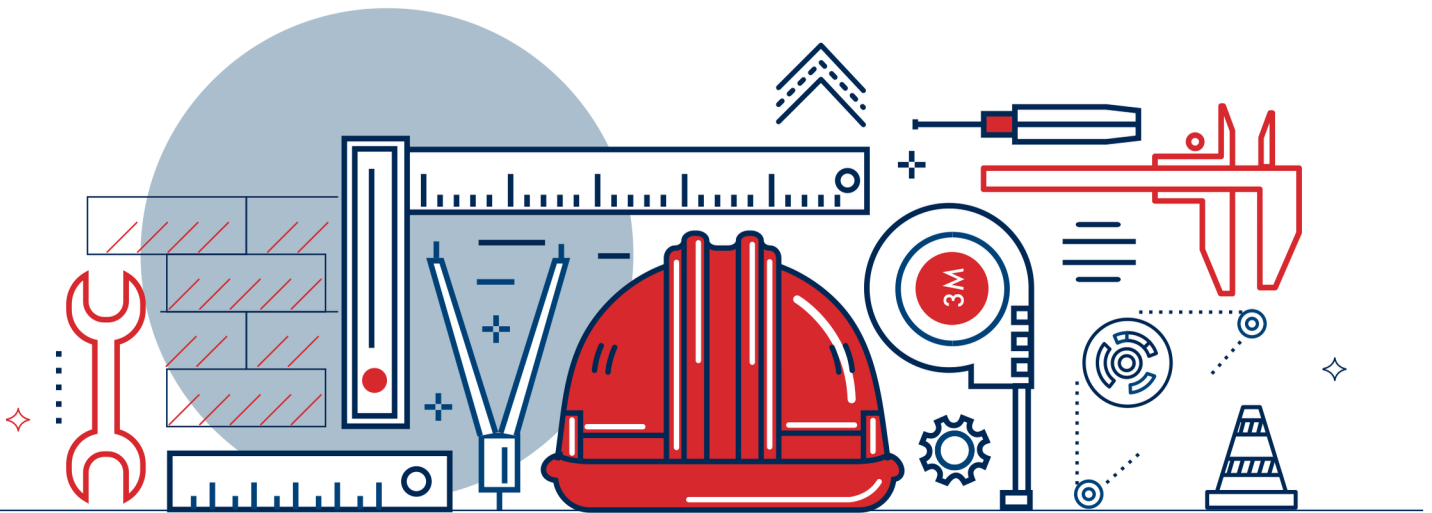

Upcoming Engineering Contracting Co.

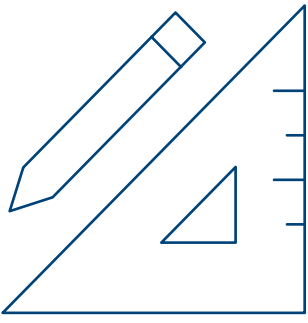

TABLE OF CONTENT

WHO WE ARE?	4
COMPANY'S STRATEGY	5
COMPANY POLICY	6
SERVICES	8
TECHNICAL INSPECTION SERVICES	8
HEAVY EQUIPMENT RENTALS & MAINTENANCE SERVICES	8
CONTRACTING (CIVIL, MECHANICAL, E&I)	9
CIVIL DIVISION	9
MECHANICAL DIVISION	10
ELECTRICAL, INSTRUMENT & TELECOMMUNICATION DIVISION	17
CLIENT	19
PROJECT	22
ORGANIZATION CHART	28

“Solid Values with a New Identity”



WHO WE ARE

OVERVIEW

UEC The ownership and management of **Upcoming Engineering Contracting**, hereafter referred to as UEC, provide qualified consulting personnel to the Oil, Gas, Petrochemical, infrastructure, and power Industries sectors.

UEC is pleased to provide the industry with highly qualified consulting personnel dedicated to Contracting Management, Materials Engineering, Welding Engineering, Project Management, Materials Application and Design, Quality Engineering, Quality Assurance/Quality Control and all types of equipment services.

UEC was formed in Saudi Arabia in 2015 and its global headquarters is in Al Khobar, registered with **CR # (Main CR no: 1112100062, Branch CR No: 2051162996).**

UEC holds approved **vendor status (10061818) with Saudi Aramco** and delivers technical expertise to diverse clients across Saudi Arabia and is focused on providing services also in Gulf Coast Countries & the Middle East.

Our current business activities include professional services related to Civil, HVAC & Electro-Mechanical, Electrical, Fire Protection, Piping, Plumbing, Structural, Painting & Coating, Industrial Maintenance, Supply chain & Logistics include heavy equipment rental services.



Company's Strategy

- ✓ Expansion of the product portfolio.
- ✓ Persistent efforts to increase the company's market share.
- ✓ Targeting specific customer segments.
- ✓ Strengthening relationships with current vendors/suppliers & simultaneously developing new vendors/suppliers.
- ✓ Enhancement of Systems and Inventory management.

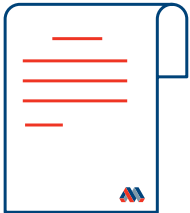

OUR MISSION

Synergizing teamwork, technology, performance, safety, and innovation to deliver exceptional customer satisfaction



OUR VISION

"Expand globally, delivering exceptional services that drive unique client value."



OUR HISTORY

High Quality Services

Since 2015

UEC POLICIES

At UEC, we are dedicated to delivering the highest quality of service by providing our clients with the most skilled and qualified professionals in the industry. We place a strong emphasis on the ongoing development and enhancement of our team's qualifications. Our commitment to excellence drives us to offer efficient, reliable, and expert consulting services, always prioritizing total customer satisfaction.

UEC is committed to collaborating closely with clients to deliver customized solutions that align precisely with their project objectives and requirements. By emphasizing meticulous planning and execution, we ensure the highest standards of quality while proactively mitigating risks and minimizing cost overruns. Our operations are governed by a fully integrated management system, independently verified to meet the rigorous standards of ISO 9001 (Quality Management System), underscoring our dedication to excellence and continuous improvement.

OUR POLICY FRAMEWORK ENCOMPASSED THE FOLLOWING KEY PRINCIPLES:

- Compliance with all relevant laws, regulations, industry standards, and best practices is strictly adhered to.
- UEC commits to developing, implementing, and sustaining a metrics-driven IMS framework, ensuring progressive enhancement
- Our team pledges dedicated service to clients, delivering projects with excellence while embracing corporate social responsibility and sustainable development.
- We commit to maintaining exceptional HSE standards, minimizing risks, and promoting a safe, healthy, and sustainable work environment. We believe that UEC represents reliability and assurance, reflecting our dedication to delivering exceptional customer experiences.
- UEC expects all employees to perform duties safely and responsibly while committing to provide comprehensive protective measures. In exchange for employees' diligent efforts, UEC pledges to provide essential safety resources and foster open communication.

"We periodically assess and update this policy, ensuring awareness and understanding among employees, contractors, and interested parties."

Date: 01/01/2025

M.Dogashim bin Dogesham
Chief Executive Officer



Upcoming Engineering Contracting Co.



SERVICES

Based on the diversity and technical expertise of our staff, the following is an overview of services offered by Upcoming Engineering Contracting Company:

1. Technical Inspection Services
2. Heavy Equipment Rentals & Maintenance Services
3. Contracting (Civil, Mechanical, E&I)

1. Technical Inspection Services

- Quality Personnel's
- QHSE Personnel's
- Project Supervision (E&I, Mechanical, Civil, HVAC, Firefighting & UG/AG piping)
- In-Service Inspection
- Technical Auditing / Supplier Assessments

2. Heavy Equipment Rentals & Maintenances Services

- **Crane rental** (Mobile cranes, tower cranes, crawler cranes)
- **Excavator rental** (Backhoes, mini excavators, long reach excavator)
- **Road rollers rental** (Vibratory rollers, pneumatic rollers, single drum rollers)
- **Forklift rental** (Heavy forklift, counterbalance forklift, telescopic forklifts)
- **Drum Truck** (Rear dump truck, articulated dump truck, tailgate dump truck)



3. Contracting (Civil, Mechanical, Electrical, Instrumentation & Telecommunication)

1. Civil Division

UEC General Construction Division boasts an impressive track record of delivering high-quality services punctually and at competitive rates, cementing its position as an industry leader. With a proven commitment to innovation and excellence, UEC consistently delivers successful projects, earning a reputation as a trusted construction partner. We undertake a variety of projects for a wide range of valued clients - from small private developments to large Government projects.

Our civil engineering expertise encompasses comprehensive service solutions, including

- Construction of Infrastructure Development Projects
- Power Plants & Substations
- Structures Required for Oil & Gas Industries

Our core expertise and proficiency are in the areas of

- Site grading
- Excavation & Backfilling
- PCC, Reinforcement & Formworks
- Concrete Works
- RCC/ Brick Drainworks
- Finishing work

Our Civil Turnkey Projects division is spearheaded by experienced Project Managers and supported by skilled professionals, offering comprehensive Construction, Project Management, and Maintenance services.



3. Contracting (Civil, Mechanical, Electrical, Instrumentation & Telecommunication)

2. Mechanical Division

UEC mechanical services consist of Plumbing, Piping, HVAC, Welding, Coating & Painting, Specialized fire protection services, and Industrial maintenance in addition to fabrication and installation of process pipelines and equipment.

Our core expertise and proficiency are in the areas of:

- Installation and testing of Plumbing work in Buildings.
- Installation and testing of UG/AG Nonmetallic piping.
- HVAC duct fabrication, installation, air balancing, testing, and commissioning.
- Specialized Fire Safety Solutions: Sprinkler Systems, Hydrants, and Extinguishers installation.
- Process/Power piping fabrication, Welding erection, and testing.
- Protective Coatings and Painting for Industrial and Civil Infrastructure.

UEC delivers a comprehensive range of services and solutions across multiple sectors, including Power, Oil & Gas, General Industries, and Infrastructure Projects. Our operations are conducted in strict adherence to SAUDI ARAMCO standards, as well as internationally recognized codes and regulations, ensuring the highest level of quality, compliance, and reliability in every project we undertake.



I. Installation and testing of Plumbing work in Building

- PVC pipe installation for drainage network in the building.
- CPVC pipe installation for hot and cold water supply in buildings.
- Plumbing fixtures installation and testing.
- Hydro-testing for the installed piping.
- Functional test for the installed plumbing fixtures.
- Disinfection for the installed potable water pipes.

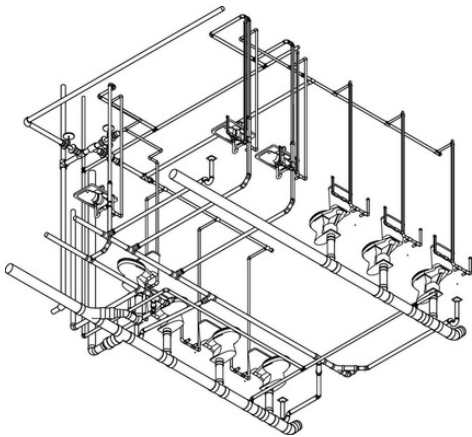
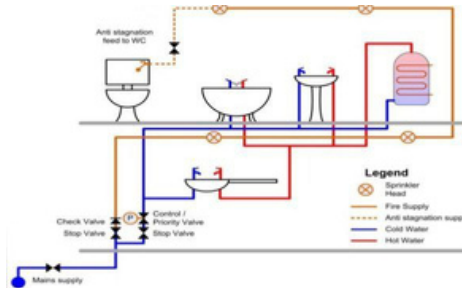

II. Installation and testing of UG/AG Non metallic Piping

- Excavation of trench for pipe laying.
- RTR (GRE, GRP, GRV) pipe laying and Installation as per approved procedure and manufacturer recommendation.
- Installation of High-Density Polyethylene Pipe (HDPE).HDPE pipe joints (Butt fusion, Electrofusion, Flange connection & Mechanical joints).
- UPVC pipe laying and installation (rubber ring joints).
- GRP Manhole and catch basin installation.
- Gravity test for the installed manhole and pipes.
- Deflection test for the installed pipes.
- Thrust Block installation for pressure piping.
- Hydrotest for the installed underground pressure pipes.



III. HVAC Duct Fabrication, Installation, Air Balancing, testing and commissioning

- HVAC duct fabrication, installation, insulation, and cladding work.
- Motorized Fire Smoke Damper, Fire Damper, Combination Fire Smoke Damper Installation, and functional testing.
- Variable Air Volume, Constant Air Volume, Duct Heater Installations.
- Wall Mounted, Floor Mounted, Roof Mounted Exhaust Fan Installation.
- HVAC Equipment Including AHU, ACCU, and Chiller Units Installation.
- Installation of Copper tube and copper piping including their Pressure testing and vacuum testing.
- Installation of Grills, Diffusers, Exhaust Air Louvers, and Fresh air Sand Trap louvers.
- Installation of DX Split Units, Ceiling suspended DX Split Units, Fan Coil Units DX Type, and Chilled Water FCU units installation.



IV. Specialized Fire Safety Solutions: Sprinkler Systems, Hydrants, and Extinguishers Installation

- Fire fighting pipe laying and installation.
- Sprinkler head installation and testing.
- Sprinkler system valve installation (shut off valves, zone control valves).
- Fire fighting system pump installation.
- Fire Alarm assembly installation.
- Fire department connection installation.
- Fire fighting system flushing and testing.
- Fire Hydrant and Post Indicator valves installation and testing.
- Fire Extinguisher installation.

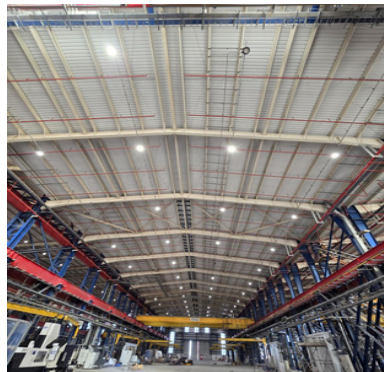

V. Process/Power Piping fabrication, Welding Erection and Testing

- Pipe fabrication and spool preparation.
- Internal cleaning of pipes before installation.
- Process/Power piping Erection.
- Hydro-testing of installed process piping.
- Piping lay-up after testing.



VI. Protective Coatings and Painting For Industrial and Civil Infrastructure

- Coating application for industrial plants and equipments.
- Internal and External coating for the pipelines and piping.
- Protective coating for industrial concrete structure.
- Viscoelastic protective coating for the buried services.
- Perform testing (holiday, chloride, abrasive test).



3. Electrical, Instrumentation & Telecommunication Divison:

UEC through its Electrical Projects department provides a portfolio of services in all phases of Electrical, Instrument and Telecommunication Construction activities. Our staff is continuously educated and familiar with NEC/ IEC / IEEE / BS / NEMA standards.

3.1 Electrical, Instrumentation

Our Expertise & Proficiency are in the areas of,

- Design, supply, and installation of comprehensive cabling solutions, including cable trays, trunking systems, and conduits.
- Design, supply, installation, testing and commissioning of low-voltage (LV) and medium-voltage (MV) electrical infrastructure.
- Comprehensive electrical and instrumentation services, including excavation, cable laying, cable management, and power distribution systems.
- High-Voltage Cable Termination and Jointing Services (up to 33kV and 36kV) and Industrial Automation Solutions.
- Turnkey Solutions: Integration, Installation, Commissioning and Start-up Services.
- Expert Transformer Revamping: Oil Filtration, Repair, and Maintenance for 400 MVA Transformers.
- Low voltage power panel installation and pre-commissioning.
- Instrument transmitter, gauges installation and testing.
- Fire Alarm and Gas detection system installation, testing, and pre-commissioning.

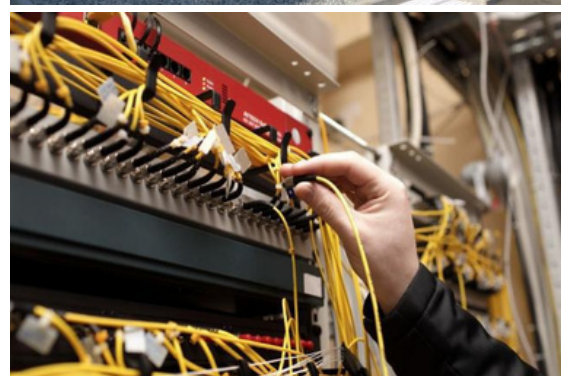

3. Electrical, Instrumentation & Telecommunication Division:

UEC through its Electrical Projects department provides a portfolio of services in all phases of Electrical, Instrumentation and Telecommunication Construction activities. Our staff is continuously educated and familiar with NEC/ IEC / IEEE / BS / NEMA standards.

3.2 Telecommunication

Our Expertise & Proficiency are in the areas of:

- Design, supply, and installation of comprehensive cabling solutions, including cable trays, trunking systems, and conduits.
- Comprehensive telecommunication services, including excavation, cable laying, cable management, and duct bank installation.
- High density drilling and sleeve installation for fiber optic cables.
- Mandrel test for the installed sleeve and duct banks.
- Sub-duct installation for the telecommunication cabling system.
- Fiber optic cable splicing and testing.
- Service post indicator markers installation.
- Telecommunication cabinet installation, cabling connection, and pre-commissioning.
- Speakers and beacon installation and testing for telecommunication.

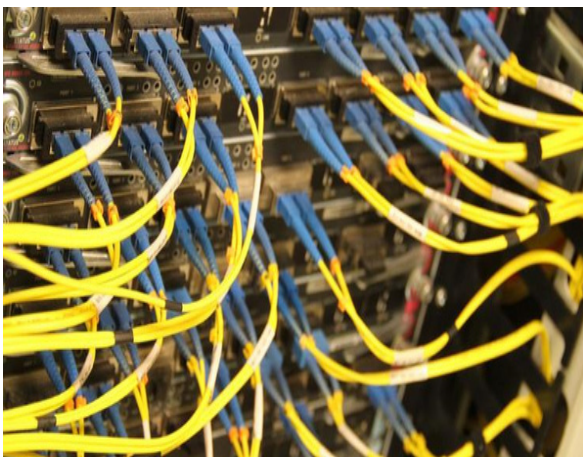

OUR

Empowering

Client Growth

since 2015



Over the years UEC, has established lasting relationships with international and national oil companies, engineering contractors as well as major international companies in related sectors.

CLIENTS INCLUDE:

1	SAUDI ARAMCO	 ارامكو السعودية Saudi Aramco
2	SINOPEC ENGINEERING GROUP SAUDI CO. LTD	 SINOPEC
3	SEPCO ARABIA COMPANY	 SEPCO 山东电建
4	BRANCH OF CHINA RAILWAY 18TH BUREAU GROUP CO. LTD	 中国铁建
5	AL-FALAK ELECTRONIC EQUIPMENT & SUPPLIERS CO.	 ALFALAK
6	AL-RASHID TRADING & CONTRACTING CO. LTD (RTCC)	 RTCC
7	SINOPEC International Petroleum Service Corporation	 SINOPEC
8	L&T HYDROCARBAN SAUDI COMPANY	 L&T Hydrocarbon

OUR

Empowering

Client Growth

since 2015



18	NASSER S AL HAJRU AND PARTNERS CONST. CO (NSH)	
19	SRACO COMPANY	
20	SAUDI INTERMAINT COMPANY LTD.	
21	RABYA GENERAL CONTRACTING	
22	CHINA COMMUNICATION CONTRACTING CO. LTD.	
23	CHINA NATIONAL CHEMICAL ENGINEERING	
24	TASNEE PETROCHEMICAL COMPLEX	
25	SAMSUNG ENGINEERING	
	AKRAD ENGINEERING & CONSTRUCTION CO.	

OUR

Success

Partner

since 2015

UEC CLIENTS

9	FREYSSINET MENARD SAUDI ARABIS LTD.	
10	NATIONAL CONTRACTING CO.LTD (NCC)	
11	ARABIAN CONTRACTING CO. LTD. (AGC)	
12	GLOBAL TECHNICAL SERVICES CO.LTD (GTS)	
13	MOHAMMAD AL-OJAIMI CONT. EST. (ENERGY SERVICE AND TRADING DIVISION)	
14	SAUDI PAN KINGDOM COMPANY (SAPAC)	
15	ARABIAN ALKANAR CO.LTD.	
16	KHALIFA A. AL MULHEM COMPANY LTD. KAMCO	
17	KIL JIN KANG & PARTNER CONST.CO.LTD (KCC)	

Shaping the future with innovative upcoming engineering contracts

UEC PROJECTS

OUR MAJOR ONGOING PROJECTS

- Construction

1. Below listed are some ongoing construction projects:

Project Name		Client	End User	Location
1	Installation of Fire Protection System in ARAMCO - Haradh Security Complex	GCS	Aramco	Haradh
2	Installation of Fire Protection System in ARAMCO - Khurais Security Complex	GCS	Aramco	Khurais
3	Installation of Fire Protection System in ARAMCO - Safaniyah Security Complex	GCS	Aramco	Safaniyah
4	Installation of Fire Protection System and RTR Work in ARAMCO - Hawtah Security Complex	GCS	Aramco	Hawtah
5	FOC Cable and Associated Materials, Installation Works-Zuluf Project	KIC	Aramco	Zuluf / Safaniyah
6	Construction of Hussein plaza (Complete Gray structure and finishing work)	ASH	ASH	Al Khobar

Overview of the Commercial Complex Project

This project involves the construction of a modern three-story commercial complex with a rooftop, covering a total built-up area of approximately 4,000 square meters. The structure will be developed as a skeleton (shell and core) building, with partial finishing work to meet the essential requirements for commercial leasing.

The complex is designed to accommodate a wide range of commercial activities, including retail outlets, offices, and recreational spaces, ensuring flexibility and adaptability for prospective tenants. The strategic design of the rooftop will allow for potential future use, such as a café, lounge, or other leisure facilities.

Key highlights of the project:

- Total Built-Up Area: Approximately 4,000 square meters.
- Floors: Three main levels with a rooftop area.
- Construction Type: Shell and core structure with selective finishing.
- Purpose: Suitable for commercial and business activities.

This development aims to provide a high-quality, versatile commercial space that meets the growing demands of modern businesses and consumers.



Shaping the future with innovative upcoming engineering contracts

UEC PROJECTS

OUR MAJOR ONGOING PROJECTS

- Technical Inspection Services

2. Below listed are some ongoing Projects of supply of Manpower in Quality Inspection Department:

	Project Name	Client	End User	Location
1	East West Pipeline Project (EWPS)	Sinopec / SEG	Aramco	Pump stations 1-11
2	Master Gas System 3 MGS-3	Sinopec / IPS	Aramco	Pump stations 6-10
3	Upgradation of fire protection & Industrial Drainage System Phase II	NESMA Projects	Aramco	Jeddah Madinah Yanbu
4	King Salman International Complex For Maritime Industries and Services (MYDP)	Sepco Arabia	Aramco / IMI	Ras-Al-Khair
5	CS Technical Support Department Inspection and Quality Assurance Section.	TUV / FAHSS	Aramco	Dammam
6	Dammam, Khobar and Safwa Aramco Boys and girls Schools	Al Falak	Aramco	Dammam, Khobar and Safwa
7	Debottleneck Onshore Plant Safaniya	ARCC / ENPPI	Aramco	Safaniya
8	Refrigeration Units & Storage Tanks at JU'AYMAH	Heisco / ENPPI	Aramco	RAS TANIA

UEC PROJECTS

OUR MAJOR ONGOING PROJECTS

- Technical Inspection Services

	Project Name	Client	End User	Location
9	Downstream Gas Pipeline Project	RTCC	Aramco	Hawiyah
10	Marjan Increment Program - PKG-13	RTCC	Aramco	Marjan
11	Berri Onshore Flow Lines & Tie-Ins	RTCC	Aramco	Jubail
12	Upgrade Buildings for Risk Mitigation Project RAS TANURA REFINERY	RTCC	Aramco	RAS TANURA
13	King Salman International Complex For Maritime Industries and Services (MYDP)	ZYCC	Aramco	Ras-Al-Khair
14	BISER Turaif Project	SISCO	Aramco	Turaif
15	Integrated Smart City Project	Wipro	Aramco	Dhahran
16	MBIPID-002 (Ras Al Khair)	Velosi	Aramco	Ras UI Khair



UEC PROJECTS

OUR MAJOR ONGOING PROJECTS

- **Technical Inspection Services**

	Project Name	Client	End User	Location
17	AMIRAL Project	NSH	Aramco	Jubail
18	CS Technical Support Department Inspection and Quality Assurance Section.	TUV / FAHSS	Aramco	Dammam
19	Master Gas System MGS - PKG 03 & PKG 12	GAS	Aramco	Shedgum / Qassim
20	Rawabi Zuluf Project	Rawabi	Aramco	Zuluf
21	Marjan Increment Program - PKG-12	Hyundai	Aramco	Marjan
22	Zuluf Industrial Support Facilities Package- 03	KIC	Aramco	Zuluf / Safaniya
23	Marjan Increment Program - PKG-16	Sinopec International	Aramco	Marjan

UEC PROJECTS

OUR MAJOR ONGOING PROJECTS

- Quality Management System

	Project Name	Client	End User	Location
1	Audits for Quality Management System (QMS, ISO-9001:2015)	DAR Consulting	DAR	Khobar

OUR MAJOR ONGOING PROJECTS

- Heavy Equipment Resources

	Project Name	Client	End User	Location
1	Master Gas System Pump stations 1-11	Sinopec	Aramco	Pump Stations (1-11)
2	Zuluf Industrial Support Facilities Package- 03	KIC	Aramco	Zuluf / Safaniya



UEC PROJECTS



SOME MAJOR COMPLETED PROJECTS

	Project Name	Client	End User	Location
1	Upgrade ELPG Facility Project	L&T Hydrocarbon	Aramco	Ras Tanura
2	Construction of PIC building in PS (1)	Larsen & Turbo (L&T)	Aramco	Pump Station (1)
3	Rifurbishment Project BI-09461 Safaniya	NHC / ENPPI	Aramco	Safaniya
4	Zuluf Project BI 12321	Denys	Aramco	Zuluf
5	Saihat Boy School Project	AGC	Aramco	Saihat Dammam
6	Package 3 Project in the City of Dhahran	Alsayed	Aramco	Dhahran
7	King Salman Energy Park (SPARK)	China Railway 18	Aramco	Abqaiq
8	Haradh project (Provided SAPID behalf of Intertek)	Intertek	Aramco	Haradh
9	EDRC PKG - 05 (280 Villas)	EFECO	Aramco	Daharan
10	North Gas Compression Plants (NGCP)	CPP	Aramco	Haradh

More Than 20 Projects completed with EPC clients at Aramco Projects.

ORGANIZATION CHART

Upcoming Engineering Contracting Co.

Mohannad Aldughayshim
Chief Executive Officer
Email: mdfd8474@uecksa.com

Rizwan Ulhaq
General Manager
Tel: +966 54 337 2150
Email: hashar@uecks.com

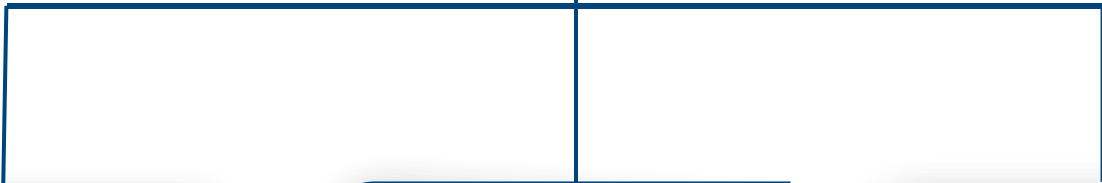

Hafiz Muhammad Ammar
Admin / HR Manager
Tel: +966 55 823 86288
Email: ammar@uecksa.com

Hafiz Tahir Bilal
Operational Manager
Tel: +966 56 229 4987
Email: tahirbilal@uecksa.com

Umaish Anwar
Marketing Mnager
Tel: +966 55 47 3503
Email: umaish@uecksa.com

Manpower List	
Description	Total
Quality Personnel	150
QHSE Personnel	30
Aramco Certified Person	50

Technical
Inspection Dept.

Equipment Rental
& Maintenance
Service Dept.

Contracts Dept.

Key Personnel Contact Details

1. Mohannad Aldughayshim (CEO)

- Email: mdfd8474@uecksa.com
- Website: www.uecksa.com

2. Rizwan Ulhaq (General Manager)

- Phone: 00966 54 337 2150
- Email: hashar@uecksa.com
- Website: www.uecksa.com

3. Hafiz Tahir Bilal (Operation Manager)

- Phone: 00966 56 229 4987
- Email: tahirbilal@uecksa.com
- Website: www.uecksa.com

4. Umaish Anwar (Marketing Manager)

- Phone: 00966 58 354 2023
- Email: umaish@uecksa.com
- Website: www.uecksa.com

5. Muhammad Sharif (Operation Supervisor)

- Phone: 00966 59 127 6048
- Email: khan@uecksa.com
- Website: www.uecksa.com

UEC specializes in providing Aramco-approved QC personnel, subcontracting services, and industrial solutions tailored to the contracting sector in Saudi Arabia."

GET IN TOUCH



Tel: **+966 13 812 8868**
Fax: **+966 54 337 2150**



www.uecksa.com



King Fahad bin Abdulaziz
Al Khobar 34427, Saudi
Arabia



hashar@uecksa.com



GET IN TOUCH

UEC WEBSITE